

KC075XP0

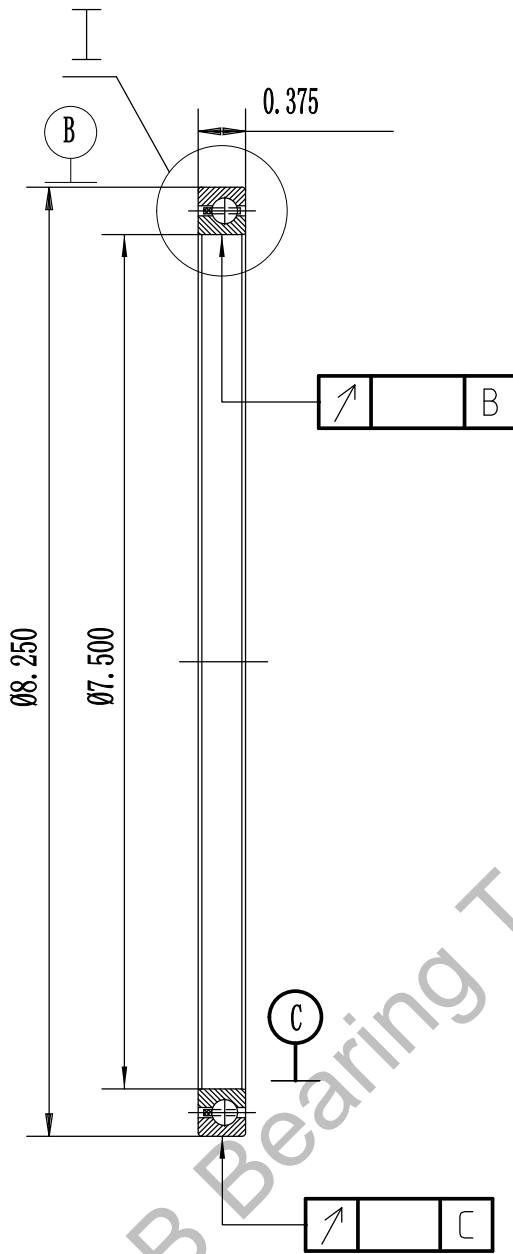

I enlarged view

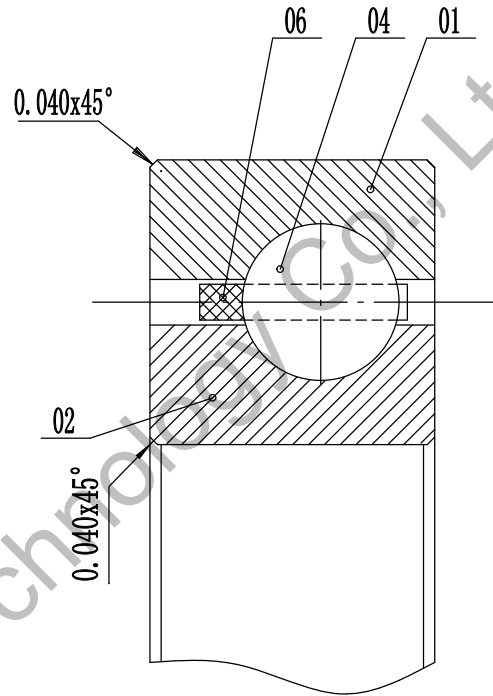

1. Radial clearance:



06	cage		nylon			
04	steel ball		AISI 52100 Steel			
02	inner ring	1	AISI 52100 Steel			
01	outer ring	1	AISI 52100 Steel			
No.	designation	qty	material	unit	total	remark
				weight (lbs)		

Luoyang JCB Bearing Technology Co., Ltd  
 Contact information  
 Company Address : No. 285 Fenghua road, Luoyang, Henan, China.  
 Postal code : 471000  
 Phone : 0086-379-68611678 Fax : 0086-379-68611679  
 E-mail: sales@jcb-bearing.com  
 Reserved E-mail: sales@thinsectionbearings.com  
 Website: www.jcb-bearing.com  
 www.thinsectionbearings.com

THIN SECTION BEARING

KC075XP0

weight(lbs)

0.78

total page 1

page 1

Luoyang JCB Bearing Technology Co., Ltd